

Springtec Super T47

Soportes Antivibratorios Caucho-Metal



DESCRIPCIÓN





Gama diseñada para la suspensión de falsos techos acústicos y maquinaria trabajando a partir de 450 r.p.m. Fabricado con muelle calidad cola de piano de gran resistencia mecánica, guiado por dos placas de caucho y con tope fin de carrera interior para evitar la posibilidad de contacto entre espiras, en caso de sobrecarga.

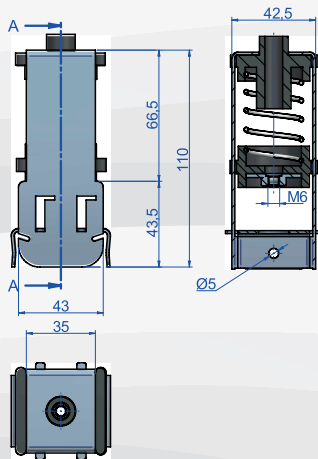

PLANOS



DIMENSIONES

	Tipo	CARGA PERMANENTE (kg)	Color muelle	Peso (kg)	Código
	Springtec Super T-47 Tipo ST-5	5	Silver	0,197	23426
	Springtec Super T-47 Tipo ST-10	10	White	0,197	23421
	Springtec Super T-47 Tipo ST-20	20	Yellow	0,21	23422
	Springtec Super T-47 Tipo ST-30	30	Blue	0,23	23423
	Springtec Super T-47 Tipo ST-60	60	Magenta	0,24	23424

PROPIEDADES ELÁSTICAS

NATURAL FREQUENCY
AMC MECANOCAUCHO SPRINGTEC

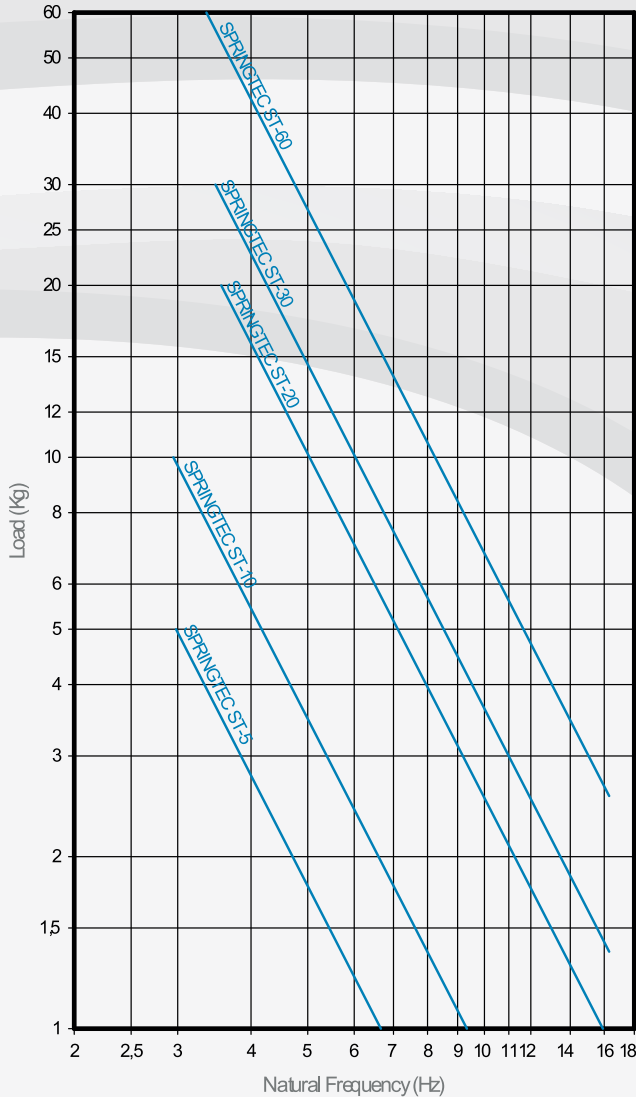

LOAD DEFLECTION GRAPH
AMC MECANOCAUCHO SPRINGTEC

